

licloc

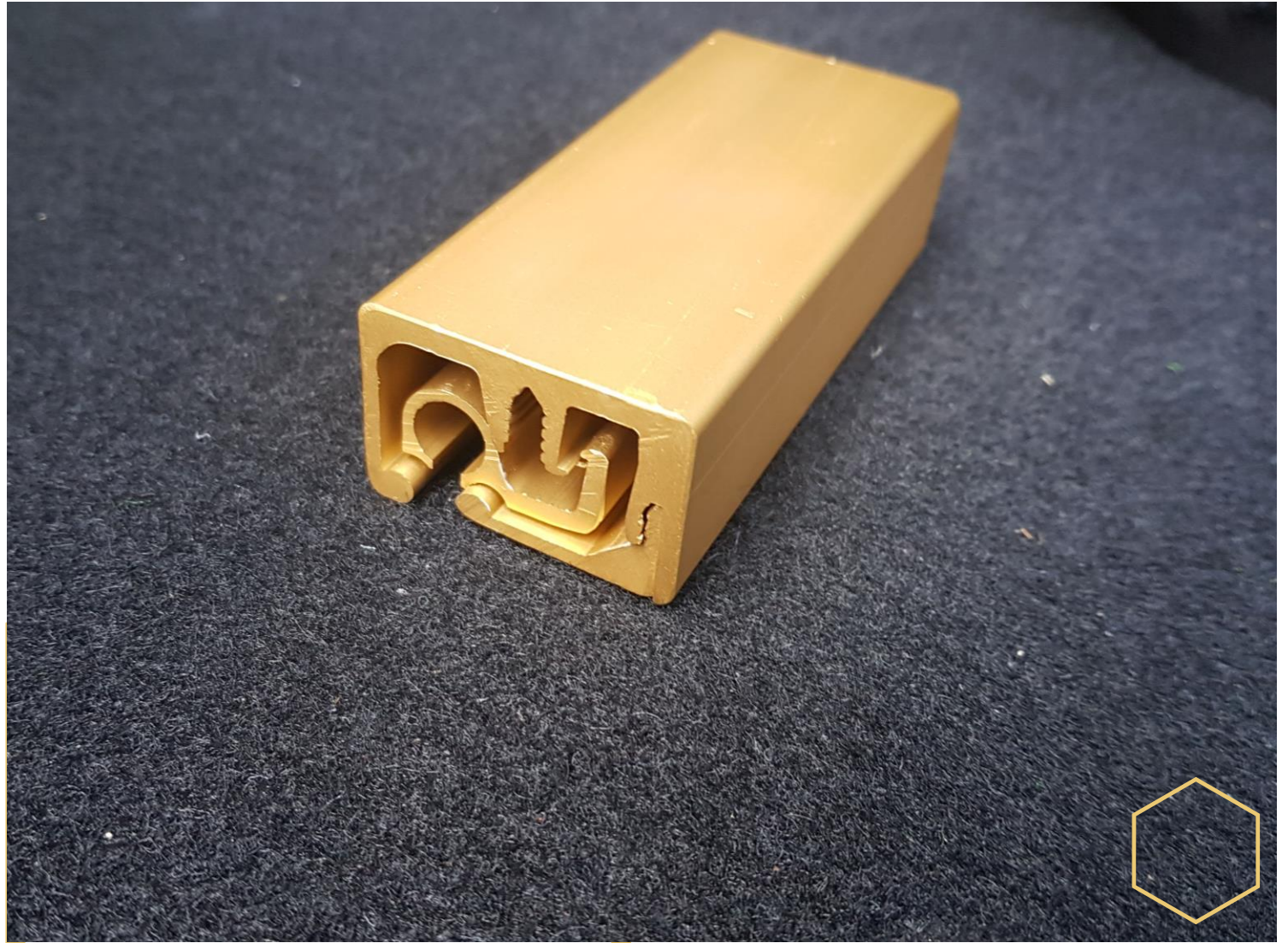

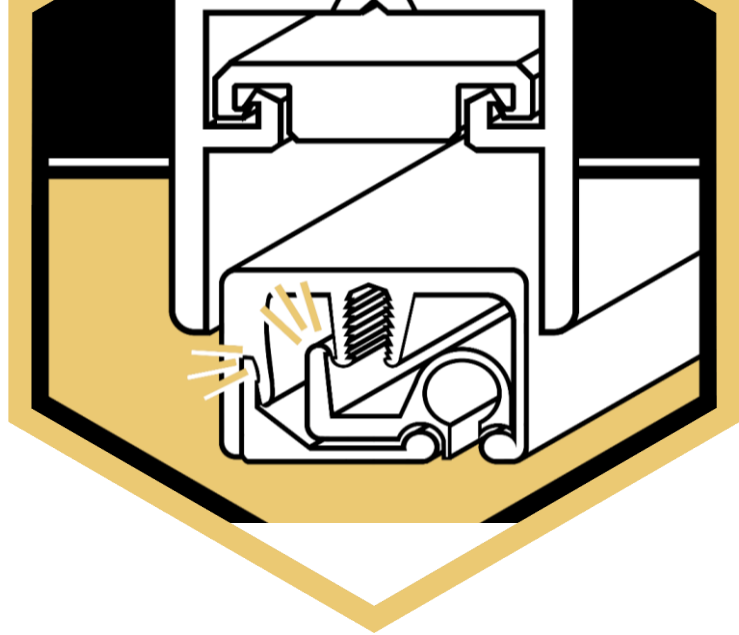

Drainage system for windows and doors



Mehrwert



das Geheimniss

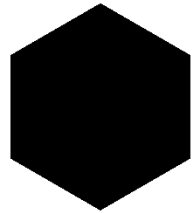

Aufnahme von hohen Zugkräften
mittels filigranen Profilen
dank durchdachter Profilanordnung

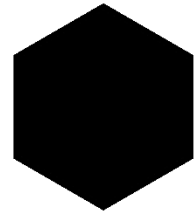

Vielfalt an Anwendungsbereiche – s. Details

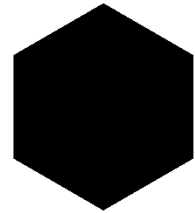

hochwertige, sehr ästhetische Komplettlösung

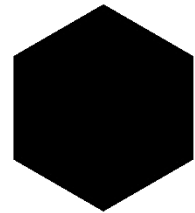

unerschlossenes Marktsegment – Textil im Bausektor



System-Prinzip



Abb.01:
Grundprofil

Mstb; 1 : 1

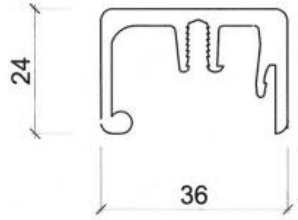

Abb.02:
Aufnahmeprofil

Mstb; 1 : 1

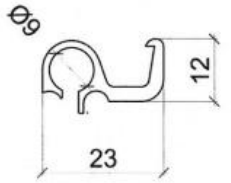

Abb.02.1:
Befestigungsmittel

Mstb; 1 : 1

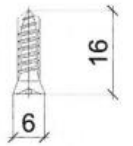

Abb.03:
Abdeckprofil

Mstb; 1 : 1



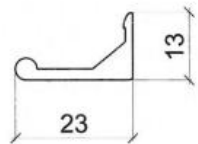
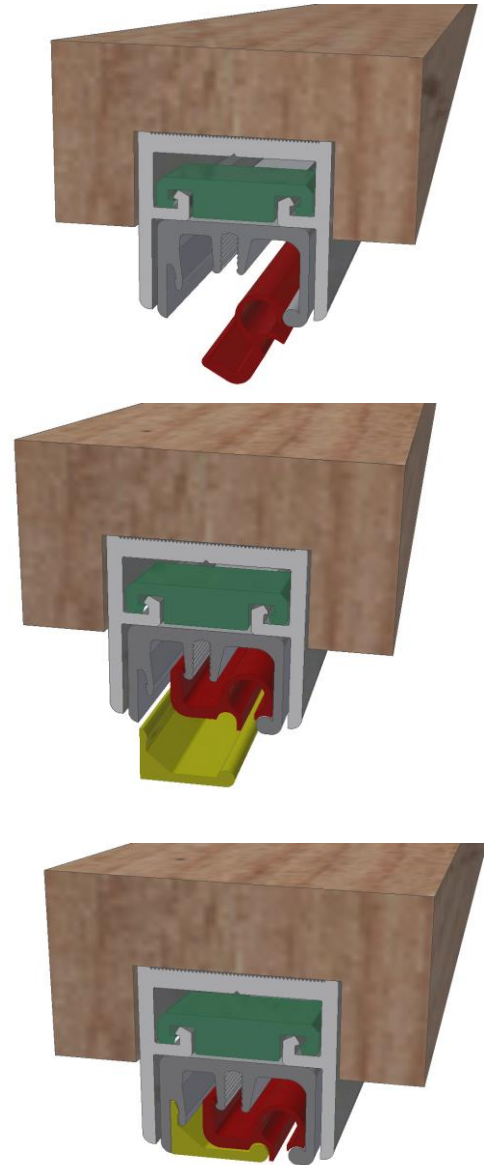
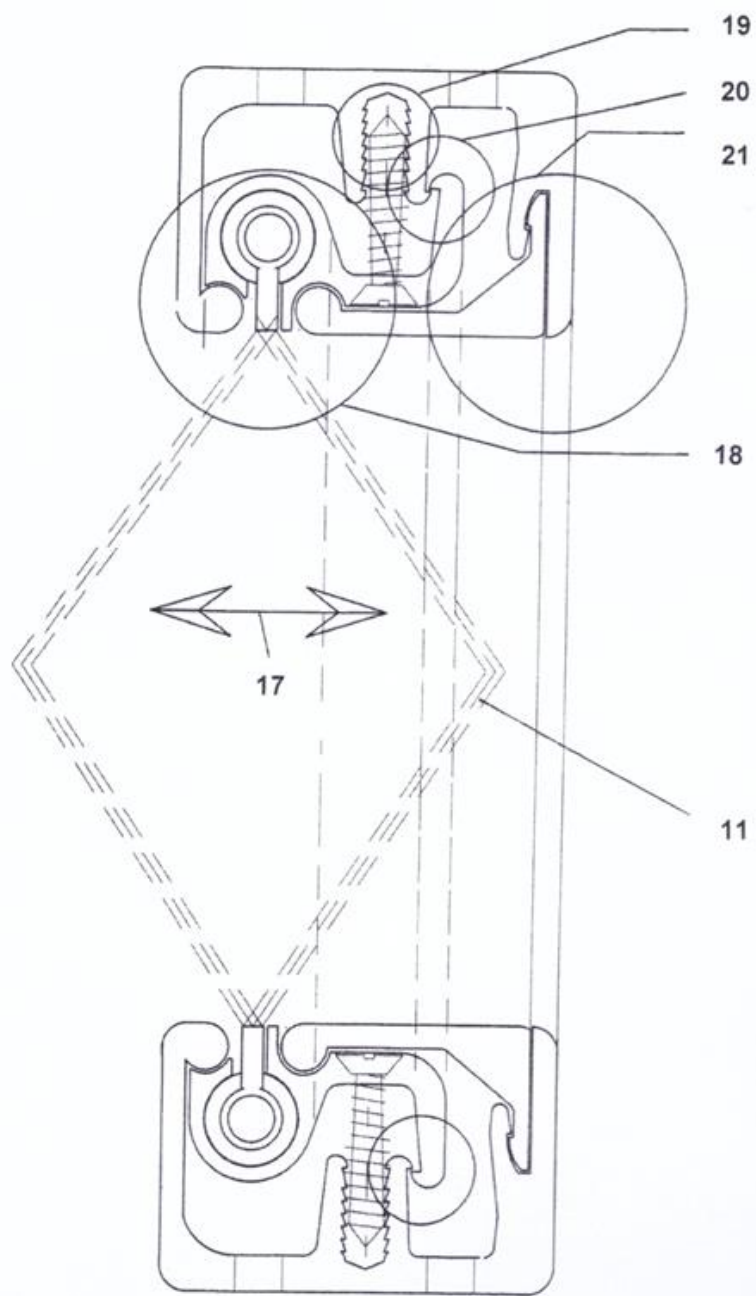

Effekt der
3. Punkt
Sicherung

17.
Zug + Druck Aufnahme
(Wind- und Schneelasten)
auf Füllungsflächen
beidseitige Abtragung
dank optimaler Profilgeometrie

Lasten gemessen von
300kg auf 60mm Systemlänge

Produkte
licloc

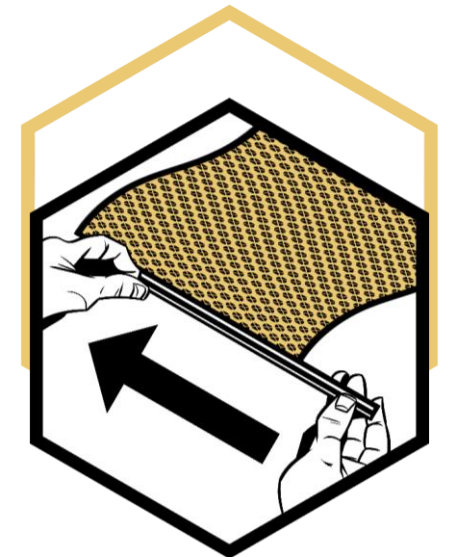



“silic”

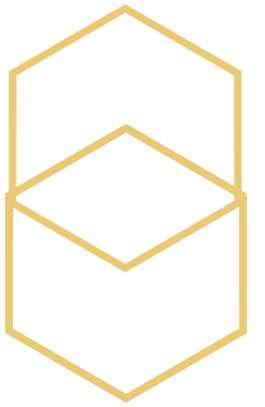

“silic- systemanwendungen”



“silic”



“silic” – Füllung - Schallabsorber



“silic – Aufnahmeprofil Saum”

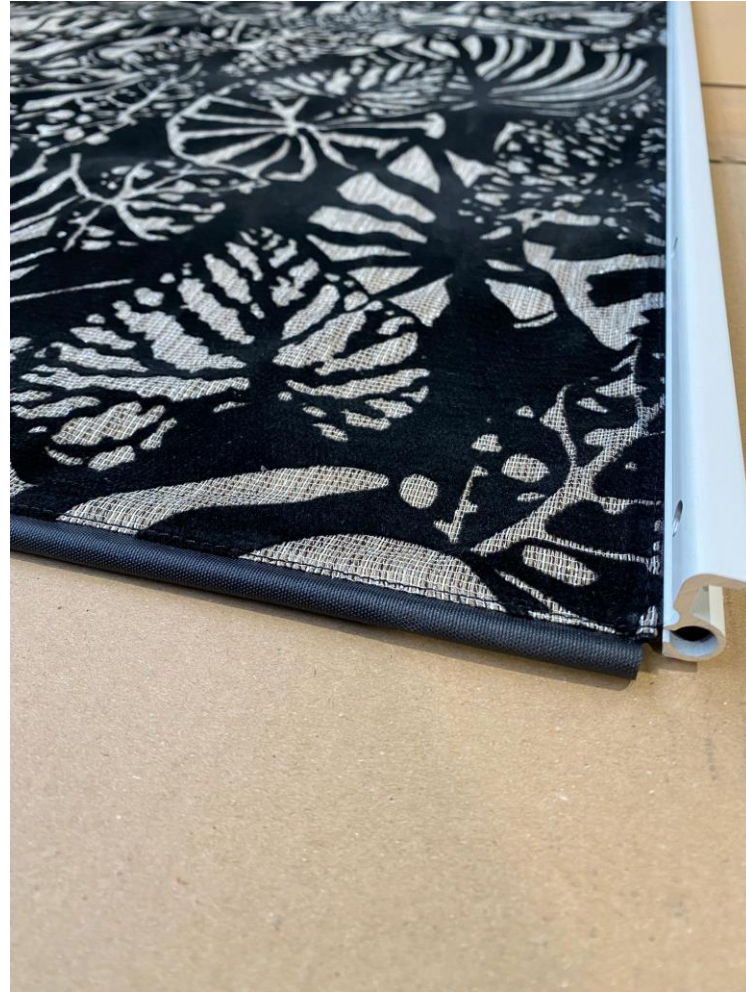
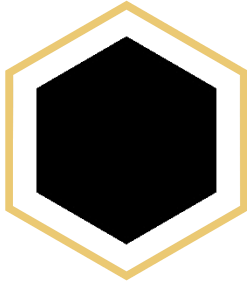



“sunloc” – Referenz

“sunloc”



graphitschwarz
7605-51198

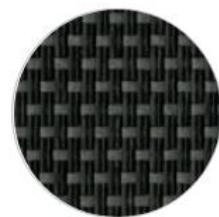

grauer pfeffer
7605-51197



sandelholz
7605-51196



vulkan
7605-51195



schatten
7605-51194



seeigel
7605-51193



seelöwe
7605-51192

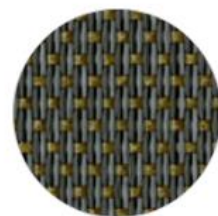

mondlandschaft
7605-51191



tundra
7605-51190

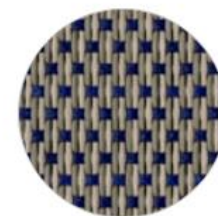

mistral
7605-51189



makadamia
7605-51188



natur
7605-51187



kumulus
7605-51186



edelweiß
7605-51185



frostweiß
7605-51184

